



SUMMER



TREKKING - NORDIC WALKING



2025



FIRZAN

MADE IN ITALY SINCE 1947

Domenico Fincati ha fondato Fizan nel 1947 ed è stato il primo al mondo a produrre bastoni da sci utilizzando l'alluminio. L'azienda ha le sue radici in Italia, ad un'ora da Venezia, dove la produzione 100% Made in Italy permette un controllo completo e costante su tutti i prodotti. I processi produttivi sono conformi a tutte le normative europee circa il divieto di utilizzo di sostanze dannose.

Domenico Fincati founded Fizan in 1947 and was the first in the world to produce aluminum ski poles. The company is situated in Italy, one hour from Venice, where 100% Made in Italy production is a complete and constant control over all products. The production processes comply with all European regulations regarding the prohibition of the use of harmful substances.



In un'ottica di sostenibilità Fizan non stampa più nessun catalogo, riducendo l'utilizzo della carta, per passare da un catalogo cartaceo ad uno digitale. I cataloghi sono facilmente accessibili dal nostro sito Web con un semplice clic. Notizie e aggiornamenti sono disponibili attraverso i nostri social network.

As part of the Fizan drive to be even more green, we will no longer produce a printed catalogue. This has been replaced with a digital catalogue which is easily accessible from our web site by a simple click. News and updates will be available through our social networks.

Fizan riduce l'impatto ambientale con imballaggi 100% riciclabili, e composti da materiale proveniente da foreste gestite in maniera responsabile e sostenibile. Gli inchiostri utilizzati sono a base d'acqua (non tossici). Ogni singolo articolo prodotto è facilmente smaltibile per essere riciclato.

Fizan reduces the environmental impact with 100% recyclable packaging, and composed of material from forests managed in a responsible and sustainable way. The inks used are water based (non-toxic). Every single item produced is easily disposable for recycling.

Da più di 10 anni Fizan ha investito nell'impianto fotovoltaico diventando così, autosufficiente per circa il 60% del proprio fabbisogno ed evitando l'emissione annua di circa 25.000 kg di CO2.

For almost 10 years Fizan has invested in the photovoltaic system thus becoming self-sufficient for about 60% of its needs and avoiding the annual emission of around 25,000 kg of CO2.



BLISTER IN
CARTONE
CARTON
BLISTER



SACCHETTO IN
PLASTICA CON
ACCESSORI
PLASTIC BAG WITH
ACCESSORIES



ALLUMINIO

Fizan utilizza solamente le due migliori leghe nel mercato: 7001 e 7075. Questi due materiali ci permettono di poter lavorare con spessori sottili ma resistenti.

ALUMINUM

Fizan uses only the two best alloys on the market: 7001 and 7075. These two materials allow us to work with thin but resistant thicknesses.



SISTEMA DI BLOCCAGGIO ESTERNO

Il sistema di bloccaggio Lever è molto intuitivo ed offre un'alta tenuta grazie alla chiusura in alluminio. Le sue dimensioni ridotte mantengono un ottimo bilanciamento del bastone durante il trekking.

EXTERNAL LOCKING SYSTEM

The Lever locking system is very intuitive and offers safe and secure tightness thanks to aluminium closer. The reduced dimensions keeps a perfect balance of the pole during all aspects of trekking.

LEVER LOCKING SYSTEM



PASSAMANO

Nel trekking viene sempre privilegiata la leggerezza ed il comfort, per questo motivo anche il passamano è reso confortevole e resistente grazie all'utilizzo di materiali pregiati.

STRAP

In trekking, lightness and comfort are always privileged, which is why the handrail is also made comfortable and resistant thanks to the use of refined materials.



TREKKING

MISURE LASER

Fizan è l'unico produttore ad utilizzare il laser per segnare la regolazione delle misure nel bastone telescopico. Questo processo garantisce una resistenza illimitata durante l'utilizzo.

LASER SIZING MARKS

Fizan is the only producer to use the laser to mark the setting of the measurements in the telescopic poles. This process guarantees unlimited resistance during use.



SISTEMA DI BLOCCAGGIO INTERNO

Il sistema di bloccaggio Flexy mantiene un bilanciamento ottimale del bastone. Il perno in alluminio ed il suo espansore Delrin (by Dupont) garantiscono una tenuta superiore ai 100 kg.

INTERNAL LOCKING SYSTEM

The Flexy inner locking system is made with an aluminum pin and Delrin (Dupont material) expander. This assures a safe and constant tightness of more than 100kg (220 pounds) during use.

FLEXY SYSTEM



PUNTA

Fizan propone due diverse tipologie di punta: una in acciaio ed una in metallo duro che assicura resistenza e durabilità nel tempo.

TIP

Fizan offers two different tip types: one in steel and one in carbide that ensures strength and durability over time.



DESIGN

Grazie ad una tecnica unica nel suo settore, Fizan riesce ad ottenere una elevata risoluzione grafica nei suoi prodotti. Le grafiche vengono effettuate da uno studio grafico interno nell'azienda.

DESIGN

Unique and advanced technology, Fizan provides exceptional high resolution graphics of products. The graphics are made by an internal graphic studio in the company.



MANOPOLE

Fizan è alla ricerca costante per migliorare l'ergonomia delle impugnature. Per questo vengono utilizzati i migliori materiali, leggeri e confortevoli.

GRIPS

Fizan is continuously searching to improve design, functionality and comfort for ergonomic grips. This is why the best materials are used, light and comfortable.



TAPPI

I tappi proteggono la punta durante il trasporto e durante l'utilizzo indoor del bastone. Fizan propone diverse varianti per forma e materiali.

TIP PROTECTOR

Tip protector protects the tip during transport and during the use of the poles indoors. Fizan offers different variations in shape and materials.



COMPACT 1947
Desert

COMPACT PRO
Grey

COMPACT 4
Water green

COMPACT 4
Grey

COMPACT
Green

COMPACT
Red

COMPACT
Grey

COMPACT
Pink

COMPACT
Ocean blue

COMPACT
Beige

Limited edition

COMPACT WORLD'S LIGHTEST 158 GRAMS

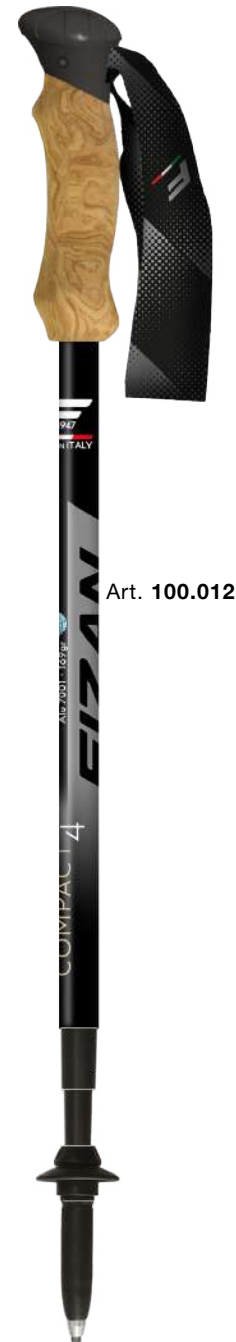
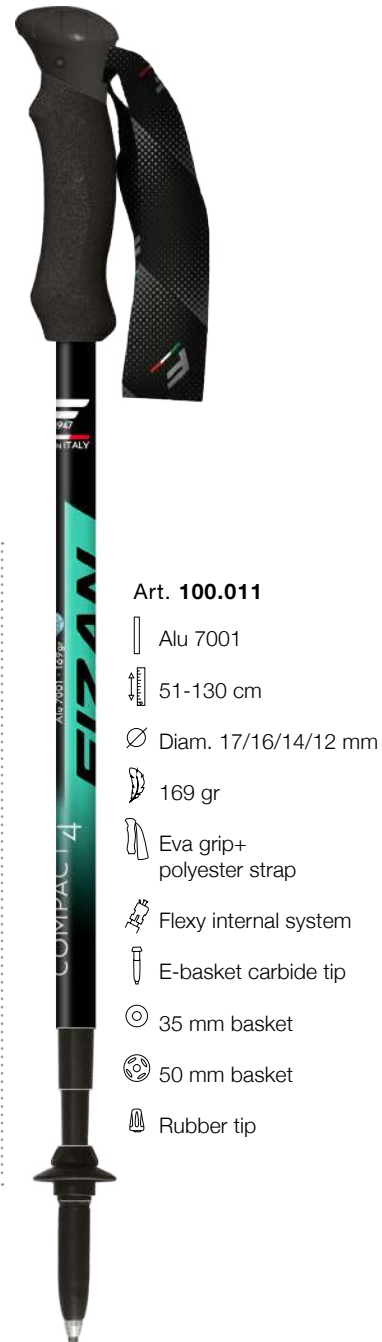
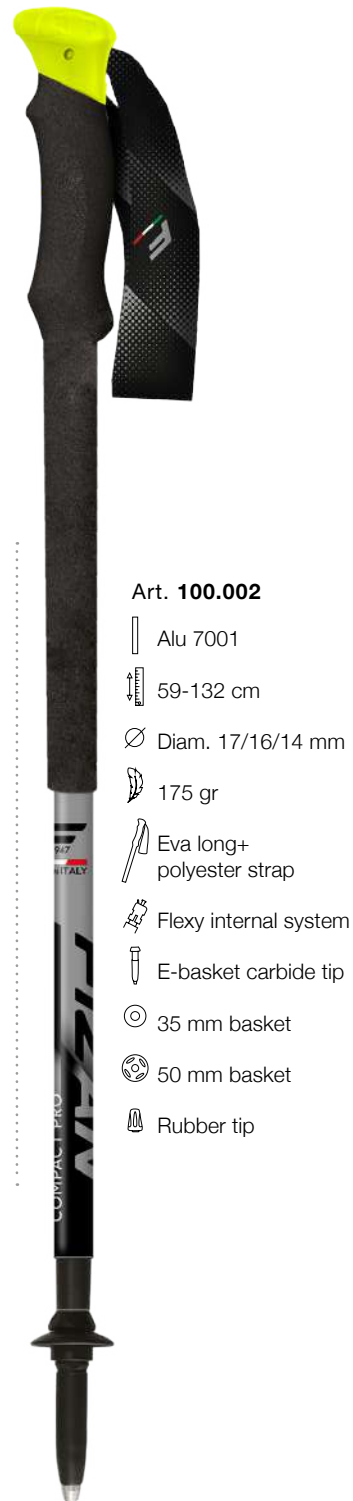

Compact, il bastone telescopico più leggero al mondo, solo 158 grammi realizzato in 3 sezioni in lega di alluminio 7001.
Compact, the world's lightest telescopic pole, only 158 grams, produced in 3 sections in aluminium alloy 7001.



COMPACT MS Black



- Art. 100.003
- Alu 7001
 - 59-132 cm
 - Ø Diam. 17/16/14 mm
 - 158 gr
 - Eva grip+ polyester strap
 - Flexy internal system
 - E-basket carbide tip
 - 35 mm basket
 - 50 mm basket
 - Rubber tip
 - Multi scarf 40 cm included



COMPACT MS Magenta



- Art. 100.004
- Alu 7001
 - 59-132 cm
 - Ø Diam. 17/16/14 mm
 - 158 gr
 - Eva grip+ polyester strap
 - Flexy internal system
 - E-basket carbide tip
 - 35 mm basket
 - 50 mm basket
 - Rubber tip
 - Multi scarf 40 cm included



LOCK ANTISHOCK

Ammortizzatore integrato che allevia il carico sulle articolazioni durante le escursioni.

Integrated shock absorber that relieves the load on the joints when hiking.



Regolare e bloccare il bastoncino all'altezza desiderata, ricordandosi di non oltrepassare la linea "STOP".

Adjust and lock the pole at the desired height, remembering not to cross the "STOP" line.

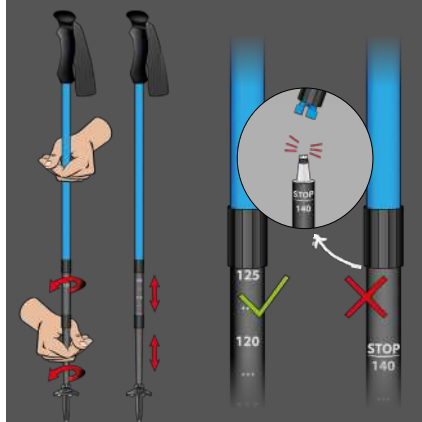

Per attivare o disattivare il sistema Antishock ruotare il bastone in senso orario / antiorario fino al "click" (ON).

To activate Antishock system or not just rotate the pole clockwise / counterclockwise until "click" (OFF).

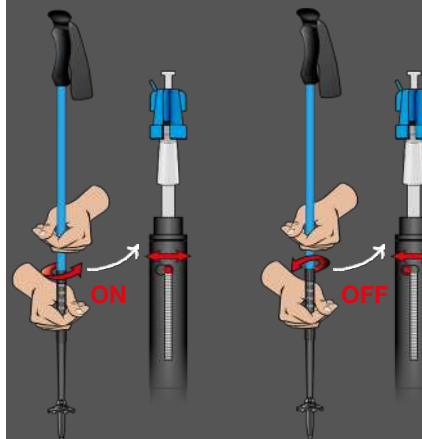

ADVENTURE Desert



- Art. 100.013
- Alu 7075
 - 70-140 cm
 - Ø Diam. 18/16/14 mm
 - 230 gr
 - Eva grip+ polyester strap
 - Alu lever locking system anti-unscrewing
 - E-basket carbide tip
 - 35 mm basket
 - 50 mm basket
 - Rubber tip

PRESTIGE A/S Red

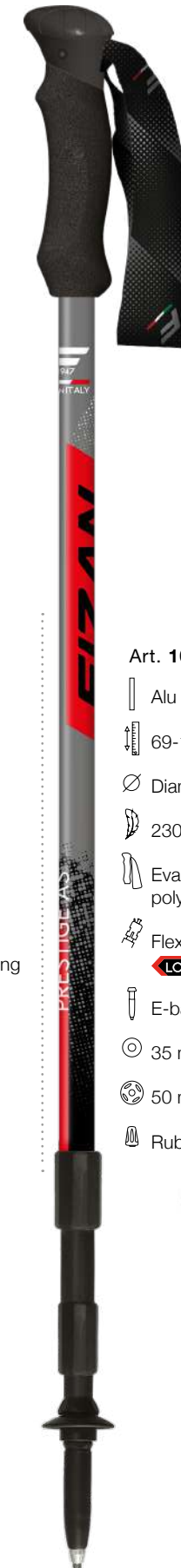

- Art. 100.014
- Alu 7075
 - 69-140 cm
 - Ø Diam. 18/16/14 mm
 - 230 gr
 - Eva grip+ polyester strap
 - Flexy internal system
 - LOCK ANTISHOCK**
 - E-basket carbide tip
 - 35 mm basket
 - 50 mm basket
 - Rubber tip

PRESTIGE Sugar paper



- Art. 100.015
- Alu 7075
 - 65-140 cm
 - Ø Diam. 18/16/14 mm
 - 220 gr
 - Eva grip+ polyester strap
 - Flexy internal system
 - E-basket carbide tip
 - 35 mm basket
 - 50 mm basket
 - Rubber tip

TREKING

VOYAGER
Petrol

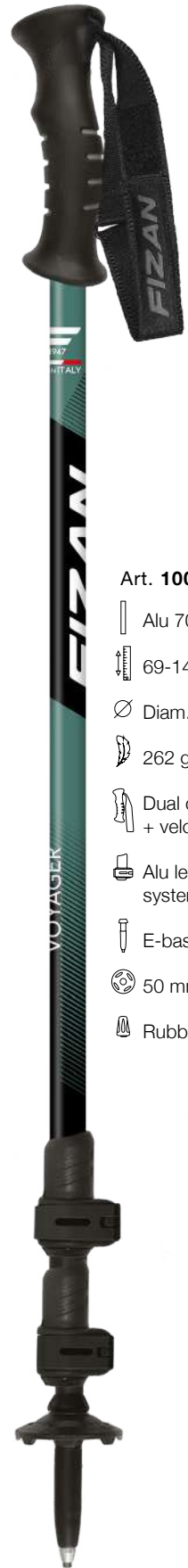









Art. 100.016

-  Alu 7075
-  69-140 cm
-  Diam. 18/16/14 mm
-  262 gr
-  Dual density rubber grip + velcro strap
-  Alu lever locking system anti-unscrewing
-  E-basket carbide tip
-  50 mm basket
-  Rubber tip

TREK
Grey



Art. 100.017

-  Alu 7075
-  63-140 cm
-  Diam. 18/16/14 mm
-  242 gr
-  Dual density rubber grip + velcro strap
-  Flexy internal system
-  E-basket carbide tip
-  50 mm basket
-  Rubber tip

TREK
Pink



Art. 100.018

TREK
Light blue



Art. 100.019

TIERRA
Beige/water green



Art. 100.020

-  Alu 7075
-  63-140 cm
-  Diam. 18/16/14 mm
-  226 gr
-  Rubber cork grip + velcro strap
-  Flexy internal system
-  E-basket carbide tip
-  50 mm basket
-  Rubber tip

TIERRA
Grey/coral







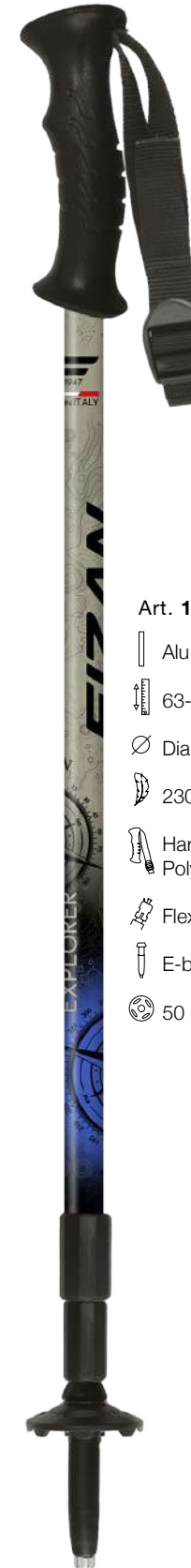



Art. 100.021

EXPLORER
Beige/blue



Art. 100.022

-  Alu 7075
-  63-140 cm
-  Diam. 18/16/14 mm
-  230 gr
-  Hard PE grip + Polypropilene strap
-  Flexy internal system
-  E-basket steel tip
-  50 mm basket

EXPLORER
Lime/grey



Art. 100.023

TREKING

WALKING

PROMENADE
Grey

CLASSIC MICRO
Grey

CLASSIC MICRO
Magenta

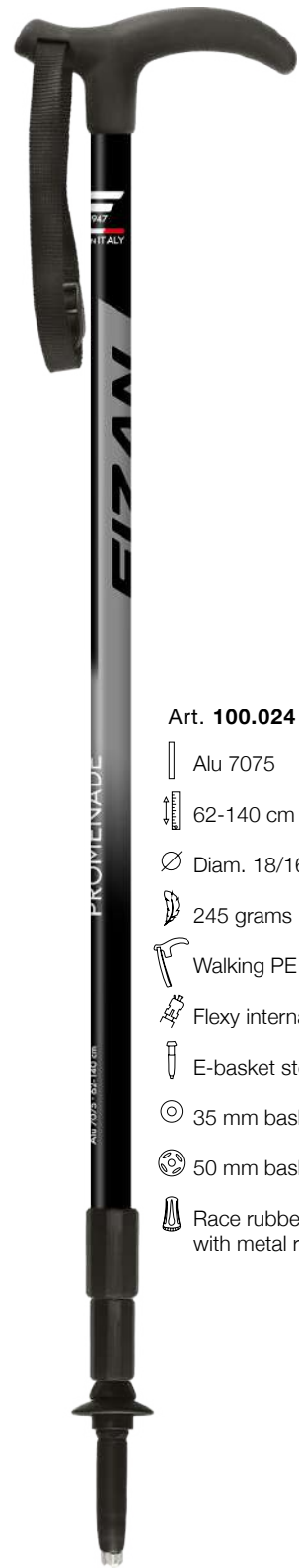

- Art. **100.024**
- Alu 7075
 - 62-140 cm
 - Diam. 18/16/14 mm
 - 245 grams
 - Walking PE grip
 - Flexy internal system
 - E-basket steel tip
 - 35 mm basket
 - 50 mm basket grey
 - Race rubber with metal ring

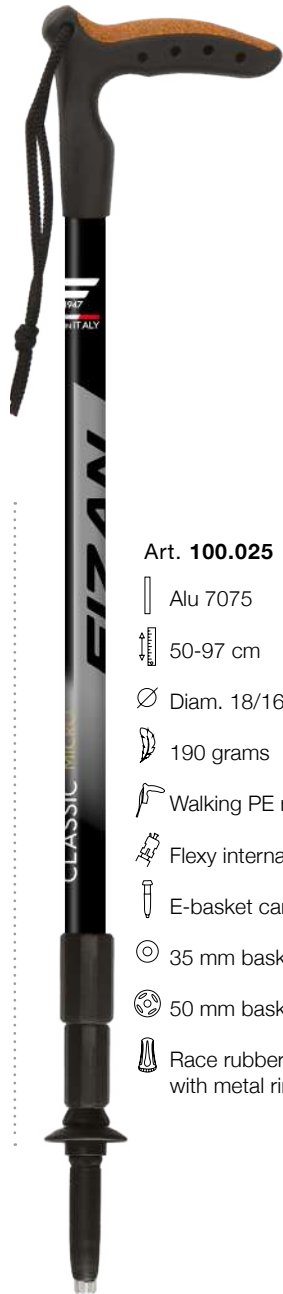

- Art. **100.025**
- Alu 7075
 - 50-97 cm
 - Diam. 18/16/14 mm
 - 190 grams
 - Walking PE rubber grip
 - Flexy internal system
 - E-basket carbide tip
 - 35 mm basket
 - 50 mm basket
 - Race rubber with metal ring



Art. **100.026**

SKI TOURING

ARIA
Beige

ELBRUS
Orange

LHOTSE
Light blue



- Art. **100.027**
- Alu 7075
 - 102-145 cm
 - Diam. 18/16 mm
 - 245 gr
 - Eva long+ polyester strap
 - Alu lever locking system anti-unscrewing
 - E-basket "L" carbide tip
 - 120 mm basket
 - 95 mm basket
 - 50 mm basket
 - Rubber tip



- Art. **100.028**
- Alu 7075
 - 70-140 cm
 - Diam. 18/16/14 mm
 - 240 gr
 - Eva long+ polyester strap
 - Alu lever locking system anti-unscrewing
 - E-basket carbide tip
 - 95 mm basket
 - 50 mm basket
 - Rubber tip



- Art. **100.029**
- Alu 7075
 - 65-140 cm
 - Diam. 18/16/14 mm
 - 230 gr
 - Eva long+ polyester strap
 - Flexy internal system
 - E-basket carbide tip
 - 95 mm basket
 - 50 mm basket
 - Rubber tip

13
8000
CONQUISTATI

MARIO VIELMO

Alpinista italiano e guida alpina ha scalato con successo 12 vette degli ottomila. Vielmo unisce ogni avventura al desiderio di aiutare le popolazioni bisognose della regione Himalayana, raccogliendo fondi per loro. Era presente al Campo base dell'Everest nel tragico Aprile del 2015 durante il terremoto del Nepal.

Italian alpinist and mountain guide climbed 12 eight thousands summits. Vielmo joins each adventure with the desire of helping the needy population of Himalayan region, gathering funds for them. He was on Everest's Base Camp on the tragic April 2015 during the earthquake in Nepal.

| | | |
|-----------------|------|-----------|
| 1 Dhaulagiri I | 1998 | May |
| 2 Manaslu | 2000 | May |
| 3 Cho Oyu | 2001 | May |
| 4 Everest | 2003 | 23 May |
| Shisha Pangma | 2004 | September |
| 5 Gasherbrum II | 2005 | July |
| 6 Makalu | 2006 | Maggio |
| 7 K2 | 2007 | 21 July |
| 8 Kangchenjunga | 2013 | 20 May |
| 9 Annapurna I | 2016 | 1 May |
| 10 Lhotse | 2017 | 26 May |
| 11 Broad Peak | 2019 | 17 July |
| 12 Gasherbrum I | 2021 | July |
| 13 Nanga Parbat | 2023 | 6 July |



FOLDING



RAPID FIZAN POLE



IMPUGNATURA

RFP viene offerto con 3 impugnature diverse in modo da poter essere utilizzato per touring, trekking, trail running e nordic walking.

GRIP

RFP has been offered with 3 different handles for best use for touring, trekking, trail running e nordic walking.

BLOCCAGGIO CON LEVA IN ALLUMINIO

Il bastone si regola attraverso un comodo sistema a leva in alluminio che permette di scegliere la lunghezza desiderata del bastone.

LEVER LOCKING SYSTEM

Pole adjustment is made by a comfortable Lever Locking System (Aluminium Lever) which allows to choose easily the requested length.

ONE TOUCH LOCKING SYSTEM

Il sistema OTP - One Touch Locking System è un innovativo sistema di bloccaggio per bastoni pieghevoli che permette l'apertura e la chiusura del bastone in maniera molto rapida (Rapid Fizan Pole).

Una volta tolto l'elastico, infatti, il bastone si aprirà e si bloccherà da solo (figura qui sotto).

ONE TOUCH LOCKING SYSTEM

The OTP - One Touch Locking System is an innovative locking system for folding poles which allows very Rapid Opening/Closing (Rapid Fizan Pole).

Once took away the elastic string, Pole will be opened and blocked automatically (see below design).

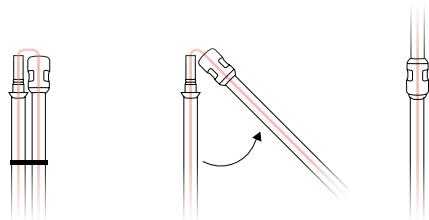

SUPERFICIE

Tutto il bastone è prodotto in lega di Alluminio 7075 con una finitura superficiale anodizzata nera, che garantisce una durata maggiore agli agenti atmosferici e ad un utilizzo estremo.

SURFACE

Whole Pole is made in 7075 Aluminim Alloy with black matt anodizing which assures a longer duration, protecting the pole by athmospherical agents and by extreme utilization.

CONFEZIONE

In dotazione viene fornita una comoda sacca dove riporre i bastoni dopo l'utilizzo. Nella confezione con blister in cartone, viene fornito anche il sacchetto con gli accessori e i manuali di istruzione e utilizzo.

PACKAGING

RFP includes a comfortable cover bag for the poles after the utilization. Inside the bag there is a small polybag with accessories and the instruction manual for a correct use and maintenance of the poles.

COME UTILIZZARLO HOW TO USE IT

Per utilizzare il bastone è sufficiente rimuovere con attenzione l'elastico di fermo, tenere il bastone con una mano e osservare la sua apertura.

To use the pole, simply remove the elastic stopper carefully, hold the pole with one hand and observe its opening.

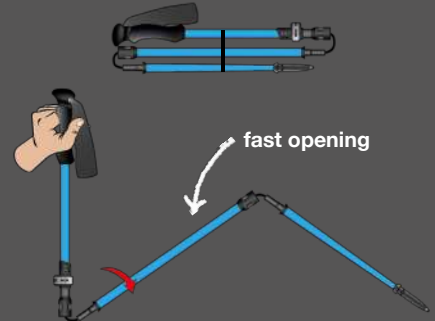

Dopo l'apertura, controllare che il sistema OTP sia ben chiuso.

After opening, check that the OTP system is closed.

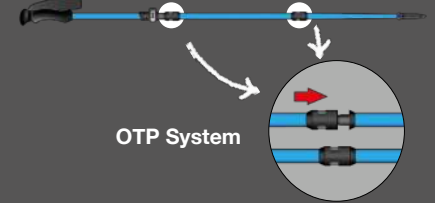

Regolare l'altezza desiderata attraverso la leva in alluminio, controllando la tenuta della stessa mediante la rotella laterale. Mai oltrepassare il segno STOP.

Adjust the height using the aluminum lever, checking its tightness using the side wheel. Never go beyond the STOP sign.

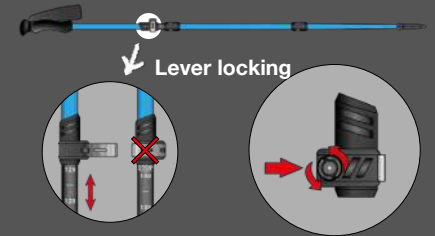

system anti-unscrewing

Per chiudere il bastone, tirare il blocco in plastica OTP e mettere l'elastico. In dotazione viene fornita una comoda borsa dove poter riporre i bastoni dopo l'utilizzo.

To close the poles, pull the OTP plastic block and put on the elastic. A convenient bag is supplied where you can store the poles after use.

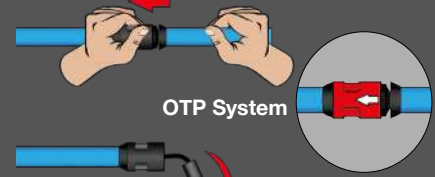

RFP TOURING Black



Art. 100.030

Alu 7075

110-135 cm

39 cm closed

Diam. 16/14/14/14 mm

260 gr

Eva long 22 cm +polyester strap

Alu lever locking system anti-unscrewing

One touch locking system

E-basket carbide tip

35 mm basket

50 mm basket

Race rubber

Bag included (16 x 42cm)



RFP TRAIL Black



Art. 100.031

Alu 7075

110-135 cm

39 cm closed

Diam. 16/14/14/14 mm

270 gr

Nw grip + FR3 Air size "M"/ FR trek

Alu lever locking system anti-unscrewing

One touch locking system

E-basket carbide tip

35 mm basket

50 mm basket

Race rubber

Bag included (16 x 42cm)



BASTONE CON ANGOLO DI CORREZIONE SOTTO L'IMPUGNATURA: VANTAGGI NORDIC WALKING POLE WITH CORRECTIVE ANGLED GRIP: ADVANTAGES

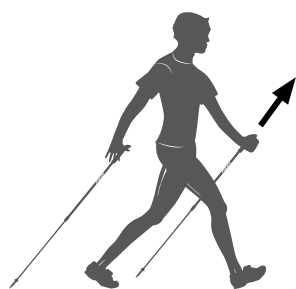

BASTONI TRADIZIONALI
TRADITIONAL POLES

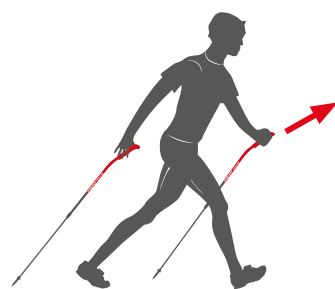

IMPULSE

il bastone IMPULSE viene utilizzato circa 3 cm più corto del bastone tradizionale
IMPULSE poles should be used about 3 cm shorter than traditional straight poles!

MAGGIORE FACILITÀ DI APPRENDIMENTO

Per i neofiti risulta più facile completare il movimento delle braccia anche senza avere l'abitudine, nella fase finale di spinta, all'apertura della mano. Facilitando così l'apprendimento della tecnica corretta.

QUICK AND EASY TO LEARN

The angled grip allows your arm to extend completely making the Nordic Walking technique easy to learn.

PRESA PIÙ IMMEDIATA SUL TERRENO

La maggior inclinazione della manopola permette di mantenere il bastoncino più in verticale. Questo consente automaticamente un appoggio più avanti rispetto al bastone tradizionale.

BE FASTER WITH BETTER GRIP

The angled grip helps keep the pole in a more vertical position resulting in greater comfort and performance over traditional poles.

USO PIÙ INTENSO DELLA MUSCOLATURA

L'inclinazione dell'impugnatura consente di accentuare l'impegno muscolare aumentando i tempi di durata per tutto il gesto tecnico.

GREATER USE OF MUSCLES

Make the most of your training session. The angled grip results in a greater use of your muscles and a better workout.

MINOR UTILIZZO DEI POLSI

La migliorata capacità di recupero del bastone e l'appoggio avanzato comportano una minor rotazione del polso. In questo modo si ottiene una posizione più ergonomica ed naturale.

LESS WRIST USE

With a more ergonomic grip angle the pole contacts with the ground earlier resulting in less wrist rotation and greater comfort.

MAGGIORE SPINTA NELLA FASE INIZIALE

Il grado di inclinazione della manopola permette un incremento della componente orizzontale del vettore forza e quindi un incremento della spinta in avanti.

MORE THRUST IN THE STARTING PHASE

The degree of handle inclination allows an increase of the horizontal component of the force vector, resulting in greater forward thrust.

CARBON PRO IMPULSE

Red

TEKNO RACE IMPULSE

Grey



size 107-120 Art. **100.032**
size 117-130 Art. **100.033**

Alu 7075 / Carbon 80

107-120 cm
117-130 cm

Ø Diam. 16/14 mm

175 gr (117-130 cm)

Nw grip + FR3 Air

Alu lever locking
system anti-unscrewing

N35 race carbide tip

Nordic rubber tip
with metal ring

size 107-120 Art. **100.034**
size 117-130 Art. **100.035**

Alu 7075

107-120 cm
117-130 cm

Ø Diam. 16/14 mm

190 gr (117-130 cm)

Nw grip + FR3 Air

Alu lever locking
system anti-unscrewing

N35 race carbide tip

Nordic rubber tip
with metal ring

NORDIC WALKING

MANOPOLA E PASSAMANO

La manopola per il nordic walking è stata studiata nella sua forma e nei materiali per essere leggera ed ergonomica. Il passamano è stato realizzato con materiali traspiranti e confortevoli per un sistema innovativo, ideato da Fizan.

HANDLE AND STRAP

The Nordic walking grip has been designed in its shape and materials to be light and ergonomic. The strap was made with breathable and comfortable materials for an innovative system, patented by Fizan.



Il stema permette attraverso una piccola pressione sul pulsante in-out, posto sulla testa della manopola, di sfilare il passamano molto velocemente. Il sistema non crea vibrazioni durante l'utilizzo. Per rendere il passamano ancora più funzionale è stato aggiunto un'inserito riflettente per maggior sicurezza al buio.

This system allows, through a small pressure on the in-out button, located on the top of the grip, to remove the strap very quickly. The system does not create vibrations during use. To make the strap even more functional, a reflective insert has been added for greater safety in the dark.

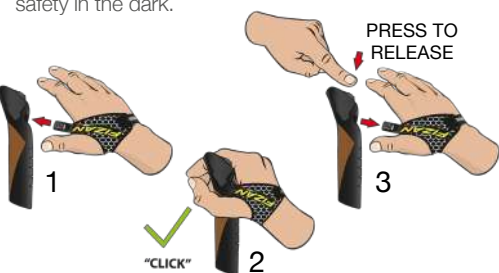

ALLUMINIO & CARBONIO

Fizan utilizza solo materia prima pregiata e di alta qualità. Le due leghe di alluminio (7001-7075) vengono fornite solo da partner certificati. Il Carbonio utilizzato nei bastoni garantisce leggerezza e ottima resistenza.

ALUMINUM & CARBON

Fizan uses only high quality raw materials. The two aluminum alloys (7001-7075) are supplied only by certified partners. The Carbon used in the pole shafts provide lightness and rigidity.



MISURE LASER

Fizan è l'unico produttore ad utilizzare il laser per segnare la regolazione delle misure nel bastone telescopico. Questo processo garantisce una resistenza illimitata durante l'utilizzo.

LASER SIZING MARKS

Fizan is the only producer to use the laser to mark the setting of the measurements in the telescopic poles. This process guarantees unlimited resistance during use.



SISTEMA DI BLOCCAGGIO INTERNO

Il sistema di bloccaggio Flexy mantiene un bilanciamento ottimale del bastone. Il perno in alluminio ed il suo espansore Delrin (by Dupont) garantiscono una tenuta superiore ai 100 kg.

INTERNAL LOCKING SYSTEM

The Flexy inner locking system is made with an aluminum pin and Delrin (Dupont material) expander. This assures a safe and constant tightness of more than 100kg (220 pounds) during use.



SISTEMA DI BLOCCAGGIO ESTERNO

Il sistema di bloccaggio Lever è molto intuitivo ed offre un'alta tenuta grazie alla chiusura in alluminio. Le sue dimensioni ridotte mantengono un ottimo bilanciamento del bastone durante il trekking.

EXTERNAL LOCKING SYSTEM

The Lever locking system is very intuitive and offers safe and secure tightness thanks to aluminium closer. The reduced dimensions keeps a perfect balance of the pole during all aspects of trekking.



DESIGN

Fizan per realizzare la grafica nei suoi bastoni utilizza o la tecnica della sublimazione o la tecnica della serigrafia. Le grafiche vengono effettuate da uno studio grafico interno nell'azienda.

DESIGN

Fizan uses the sublimation or screen printing technique to create the graphics in his poles. The graphics are made by an internal graphic studio in the company.



PUNTA

Per una camminata classica di nordic walking Fizan propone la punta in metallo duro. Per i più esperti invece, propone la punta "Race", anch'essa in metallo duro. Per la versione Junior consiglia la punta in acciaio.

TIP

For a classic nordic walking walk Fizan offers carbide tip. For the more experienced, instead, he proposes the "Race" tip, in carbide. For the Junior poles recommends the steel tip.



TAPPI

Fizan propone due varianti di tappi, disponibili anche con inserto metallico all'interno, per avere più durabilità del tempo. Nordic rubber tip e race rubber.

TIP PROTECTOR

Fizan offers two variants of tips, also available with a metal ring inside, to have more durability of the time Nordic rubber tip and race rubber.



NORDIC WALKING

CARBON RACE

Yellow



size 105 Art. **100.051**
size 110 Art. **100.052**
size 115 Art. **100.053**
size 120 Art. **100.054**
size 125 Art. **100.055**
size 130 Art. **100.056**
size 135 Art. **100.057**

- Carbon 80
- 105-135 cm
- Ø Diam. 16 mm
- 155 gr (115 cm)
- Nw grip + FR3 Air size "M"
- N35 race carbide tip
- Nordic rubber tip with metal ring



CARBON PRO

Yellow



Art. **100.036**

- Alu 7075 / Carbon 80
- 105-130 cm
- Ø Diam. 16/14 mm
- 175 gr
- Nw grip + FR3 Air size "M"
- Alu lever locking system anti-unscrewing
- N35 race carbide tip
- Nordic rubber tip with metal ring



TEKNO RACE

Yellow



Art. **100.037**

- Alu 7075
- 105-130 cm
- Ø Diam. 16/14 mm
- 190 gr
- Nw grip + FR3 Air size "M"
- Alu lever locking system anti-unscrewing
- N35 race carbide tip
- Nordic rubber tip with metal ring



NORDIC WALKING

RUNNER
Gold



size 105 Art. **100.058**
size 110 Art. **100.059**
size 115 Art. **100.060**
size 120 Art. **100.061**
size 125 Art. **100.062**
size 130 Art. **100.063**
size 135 Art. **100.064**

- Carbon 40
- 105-135 cm
- ∅ Diam. 16 mm
- 162 gr (115 cm)
- Nw grip + FR3 Air size "M"
- E-basket carbide tip
- 35 mm basket
- Nordic rubber tip

RUNNER
Blue



size 105 Art. **100.065**
size 110 Art. **100.066**
size 115 Art. **100.067**
size 120 Art. **100.068**
size 125 Art. **100.069**
size 130 Art. **100.070**
size 135 Art. **100.071**

- Carbon 40
- 105-135 cm
- ∅ Diam. 16 mm
- 162 gr (115 cm)
- Nw grip + FR3 Air size "M"
- E-basket carbide tip
- 35 mm basket
- Nordic rubber tip

RUNNER
Pink



size 105 Art. **100.072**
size 110 Art. **100.073**
size 115 Art. **100.074**
size 120 Art. **100.075**
size 125 Art. **100.076**
size 130 Art. **100.077**
size 135 Art. **100.078**

- Carbon 40
- 105-135 cm
- ∅ Diam. 16 mm
- 162 gr (115 cm)
- Nw grip + FR3 Air size "S"
- E-basket carbide tip
- 35 mm basket
- Nordic rubber tip

R-EVOLUTION PRO
Grey/beige



Art. **100.038**

- Alu 7075
- 58-130 cm
- ∅ Diam. 16/14/12 mm
- 205 gr
- Nw grip + FR3 Air size "M" /FR trek
- Alu lever locking system anti-unscrewing
- Flexy internal system
- N35 race carbide tip / E-basket carbide tip
- 35 mm basket
- 50 mm basket
- Race rubber with metal ring
- Art.202 bag trek included

R-EVOLUTION
Yellow



Art. **100.039**

- Alu 7075
- 58-130 cm
- ∅ Diam. 16/14/12 mm
- 205 gr
- Nw grip + FR3 Air size "M"
- Alu lever locking system anti-unscrewing
- Flexy internal system
- N35 race carbide tip
- Nordic rubber with metal ring
- Art.202 bag trek included

R-EVOLUTION
Grey/ocean



Art. **100.040**

- Alu 7075
- 58-130 cm
- ∅ Diam. 16/14/12 mm
- 205 gr
- Nw grip + FR3 Air size "M"
- Alu lever locking system anti-unscrewing
- Flexy internal system
- N35 race carbide tip
- Nordic rubber with metal ring
- Art.202 bag trek included

NORDIC WALKING

SPEED RACE
Grey

SPEED
Yellow

SPEED
Black

SPEED
Ocean

SPEED
Violet

SPEED
Pink



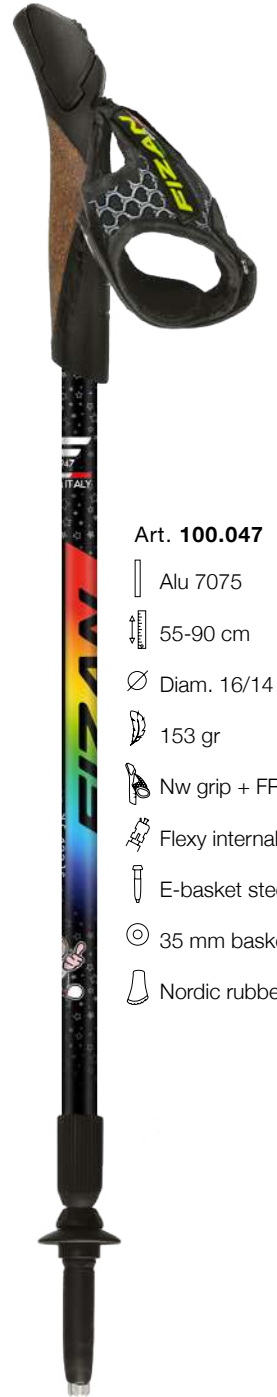





SPEED JUNIOR
Rainbow











Art. **100.041**

-  Alu 7075
-  73-125 cm
-  Diam. 16/14 mm
-  185 gr
-  Nw grip + FR3 Air size "M"
-  Alu lever locking system anti-unscrewing
-  N35 race carbide tip
-  Nordic rubber tip with metal ring









Art. **100.042**

-  Alu 7075
-  75-125 cm
-  Diam. 16/14 mm
-  185 gr
-  Nw grip + FR3 Air size "M"
-  Flexy internal system
-  E-basket carbide tip
-  35 mm basket
-  Nordic rubber tip









Art. **100.043**

-  Alu 7075
-  75-125 cm
-  Diam. 16/14 mm
-  185 gr
-  Nw grip + FR3 Air size "M"
-  Flexy internal system
-  E-basket carbide tip
-  35 mm basket
-  Nordic rubber tip









Art. **100.044**

-  Alu 7075
-  75-125 cm
-  Diam. 16/14 mm
-  185 gr
-  Nw grip + FR3 Air size "M"
-  Flexy internal system
-  E-basket carbide tip
-  35 mm basket
-  Nordic rubber tip









Art. **100.045**

-  Alu 7075
-  75-125 cm
-  Diam. 16/14 mm
-  185 gr
-  Nw grip + FR3 Air size "M"
-  Flexy internal system
-  E-basket carbide tip
-  35 mm basket
-  Nordic rubber tip

Art. **100.046**

-  Alu 7075
-  75-125 cm
-  Diam. 16/14 mm
-  185 gr
-  Nw grip + FR3 Air size "S"
-  Flexy internal system
-  E-basket carbide tip
-  35 mm basket
-  Nordic rubber tip

Art. **100.047**

-  Alu 7075
-  55-90 cm
-  Diam. 16/14 mm
-  153 gr
-  Nw grip + FR3 Air size "S"
-  Flexy internal system
-  E-basket steel tip
-  35 mm basket
-  Nordic rubber tip

NORDIC WALKING

LITE 4
Grey

LITE
Sugar paper

LITE
Coral



WALX PRO
Black

WALX VELOCITY
Black

WALX XPLOER
Black

Dall'unione della manopola Walx e del bastoncino **IMPULSE** by Fizan nasce un nuovo concetto di camminata con i bastoncini.

From the union of the Walx handle and the **IMPULSE** by Fizan pole, a new concept of walking with poles is born.

Le prime sensazioni sono:

- Senso di libertà senza avere una connessione mano/presa
- Feeling immediato e più veloce sull'utilizzo del bastone
- Maggiore attivazione muscolare
- Più divertimento camminando con i bastoncini

The first sensations are:

- Sense of freedom without having a connection between hand/grip
- Immediate and faster feeling on how to use the poles
- Greater muscle activation
- More fun walking with poles



Vantaggi utilizzando i bastoni WALX:

- Aderenza immediata al suolo **IMPULSE**
- Posizione naturale e rilassata della mano
- Spinta continua
- Corretta postura eretta
- Stile di camminata naturale e rilassato
- Utilizzo più intenso dei muscoli addominali
- Maggiore utilizzo dei muscoli delle braccia
- Meno stress sulle ginocchia
- Passo molto dinamico
- Molto facile da imparare

Benefits using WALX poles:

- Immediate grip on the ground **IMPULSE**
- Natural and relaxed position of the hand
- Continuous push
- Correct upright posture
- Natural and relaxed walking style
- More intense use of the abdominal muscles
- Greater use of arm muscles
- Less stress on the knees
- Very dynamic step
- Very easy to learn

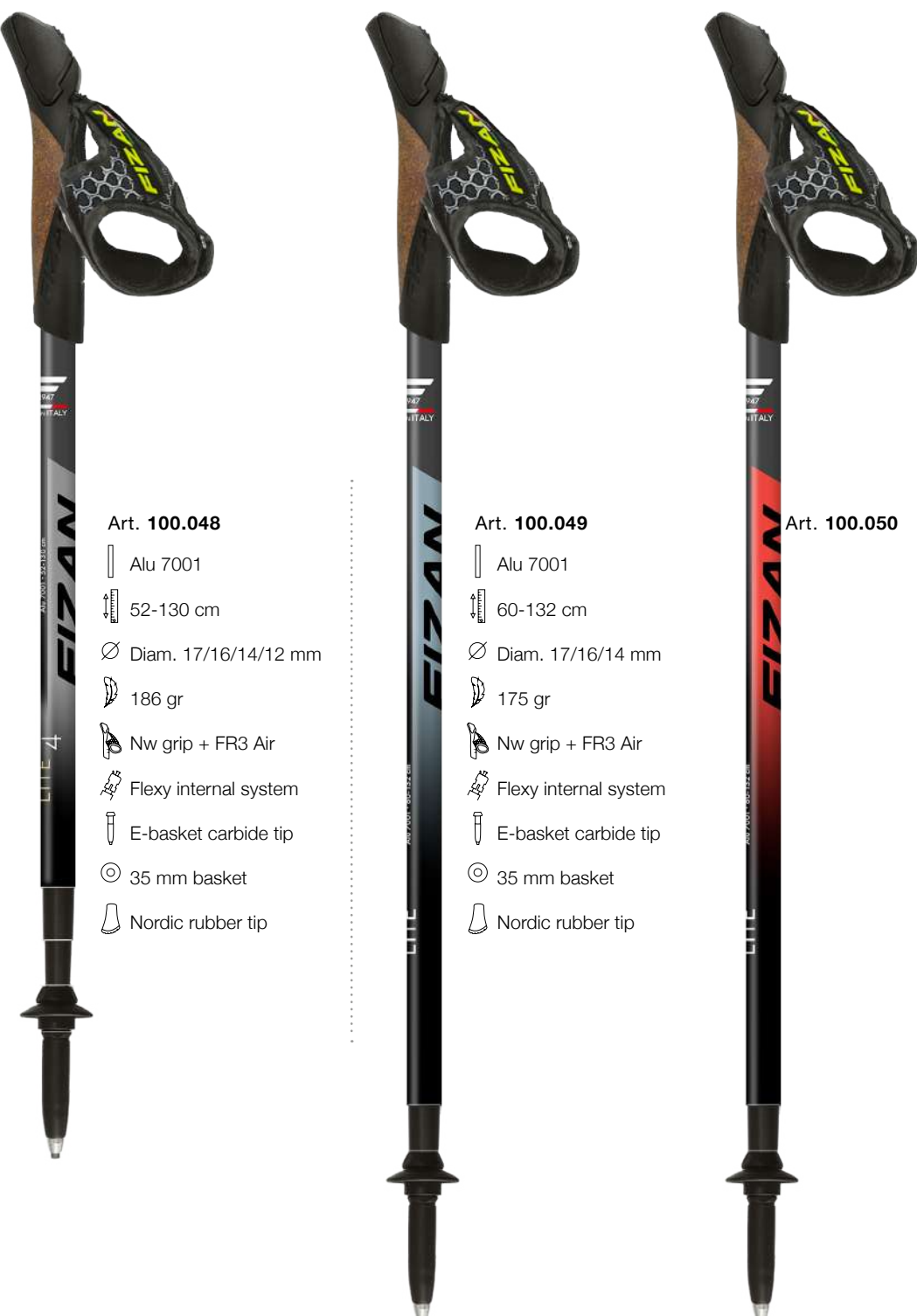

Art. **100.048**

- Alu 7001
- 52-130 cm
- Diam. 17/16/14/12 mm
- 186 gr
- Nw grip + FR3 Air
- Flexy internal system
- E-basket carbide tip
- 35 mm basket
- Nordic rubber tip

Art. **100.049**

- Alu 7001
- 60-132 cm
- Diam. 17/16/14 mm
- 175 gr
- Nw grip + FR3 Air
- Flexy internal system
- E-basket carbide tip
- 35 mm basket
- Nordic rubber tip

Art. **100.050**



size 107-120 Art. **WLXPR1001**
size 117-130 Art. **WLXPR1002**

- Alu 7075
- 107-120 cm o 117-130 cm
- Diam. 16/14 mm
- 220 gr (107-120 cm)
- Walx ergonomic handle rubber / cork
- Alu lever locking system anti-unscrewing
- E-basket carbide tip
- 35 mm basket
- Race rubber

Art. **WLXVL1001**

- Alu 7075
- 87-125 cm
- Diam. 16/14 mm
- 220 gr
- Walx ergonomic handle rubber / cork
- Flexy internal system
- E-basket carbide tip
- 35 mm basket
- Race rubber

Art. **WLXXP1001**

- Alu 7075
- 58-127 cm
- Diam. 16/14/12 mm
- 247 gr
- Walx ergonomic handle rubber / cork
- Alu lever locking system anti-unscrewing
- E-basket carbide tip
- 35 mm basket
- Race rubber
- Art.202 bag trek included



BACKPACKS

BACKPACK ACTIVE 20 Black
Art. 206B
450 grams cap. 20 lt 28 x 18 x 45 cm



BACKPACK ACTIVE 20 Yellow
Art. 206G
450 grams cap. 20 lt 28 x 18 x 45 cm



SCHIENALE

Lo schienale è adattabile ad qualsiasi anatomia ed è rivestito con un tessuto reticolato traspirante che dona comfort. La cintura sui fianchi si adatta alle anche ed alla vita, per ottimizzare il sostegno del carico.

BACK

The back is adaptable to any anatomy and covered with a breathable and reticulated fabric to giving comfort. The belt integrated on the hips adapts to the hips and waist, to optimize load support.

TASCHE ESTERNE

Lo zaino ha una capienza di 20 lt. Le tasche esterne sono 4, due laterali e due frontali, che permettono di ampliare il volume dello zaino. Le tasche sono dotate di zip ergonomiche resistenti e affidabili.

EXTERNAL POCKETS

The backpack has a capacity of 20 liters. with four external pockets, two on the front and two on the sides. This adds extra volume to the backpack. The pockets are ergonomic, resistant and reliable zippers.

SISTEMA PORTABASTONI

Sono presenti delle asole esterne sulla parte bassa dello zaino, che vengono utilizzate per inserire la punta del bastone, che viene successivamente bloccato con dei comodi elastici posti sulla parte superiore.

POLES HOLDER SYSTEM

There are external slots on the lower part of the backpack, which are used to insert the tip of the pole, which is subsequently held in place with a comfortable elastic bands on the upper part.

SPALLINE

Le spalline sono rivestite con un speciale tessuto a rete traspirante, morbido che dona comfort a chi indossa lo zaino. Le cinghie sono facili da regolare, grazie ad delle asole inserite all'estremità di esse.

SHOULDER PADS

Shoulder pads are covered with a breathable and soft mesh fabric that gives comfort to person wearing it. The straps are easy to find and easy to adjust even when the backpack is worn, thanks to the buttonholes.

AGGANCI CON FISCHIETTO

Le fibbie esterne sono modellate con la forma di un fischietto, estremamente utile nelle situazioni di pericolo.

HOOK WITH WHISTLE

The external buckle has been designed in the shape of a usable whistle. This could become extremely useful in an emergency.

COPRI ZAINO PER PIOGGIA

All'interno di una tasca sottostante è stato inserito un coprizaino per proteggere lo zaino in caso di pioggia.

RAIN COVER

Inside one of the pockets, you'll find an elasticated waterproof cover designed to protect the backpack in case of rain.

BACKPACKS & WAIST BAGS

BACKPACK ACTIVE 10 Black
Art. 208
220 grams cap. 5 lt 18 x 7 x 30 cm



Semplice e compatto, dal design moderno e accattivante, questo zaino è dotato di spalline imbottite e di una cintura per i fianchi per restare ben appoggiato al corpo durante i movimenti. Ha una capacità di 10 litri, questo lo rende uno zaino piccolo, ma allo stesso tempo molto funzionale. Dotato di molteplici tasche, quella frontale è realizzata con un tessuto traspirante morbido al tatto e leggermente espandibile, sull'esterno sono disegnati degli inserti che riflettono al buio per una maggior sicurezza durante le vostre escursioni notturne. Nella tasca sottostante è presente un comodo coprizaino per proteggere lo zaino dalla pioggia e renderlo così impermeabile.

Simple and compact, with a modern and attractive design, this backpack is equipped with padded shoulder straps and a hip belt to remain well supported by the body during movements. It has a capacity of 10 liters, this makes it a small backpack, but at the same time very functional. Equipped with multiple pockets, the front one is made of a breathable fabric that is soft to the touch and slightly expandable. Inserts are designed on the outside that reflect in the dark for greater safety during your night excursions. In the pocket below there is a comfortable backpack cover to protect the backpack from the rain and thus make it waterproof.

WAIST BAG Black
Art. 205/20B
150 grams 39 x 15 cm



WAIST BAG Yellow
Art. 205/20G
150 grams 39 x 15 cm



Marsupio con porta borraccia estraibile e regolabile attraverso una cinghia. Presenza di inserti riflettenti, sui passanti e sulla tasca, per una maggior visibilità al buio. Tessuto moderno e resistente proposto in versione nera e gialla.

Waist bag with removable bottle holder and adjustable strap. Presence of reflective inserts, on the loops and on the pocket, for greater visibility in the dark. Modern and resistant fabric available in black and yellow version.



CRAMPONS & GAITERS

CRAMPONS ICE / SNOW Art. R-124 ICE/SNOW

MATERIALS:
stainless steel
polyester
silicone



sustainable packaging, contains:

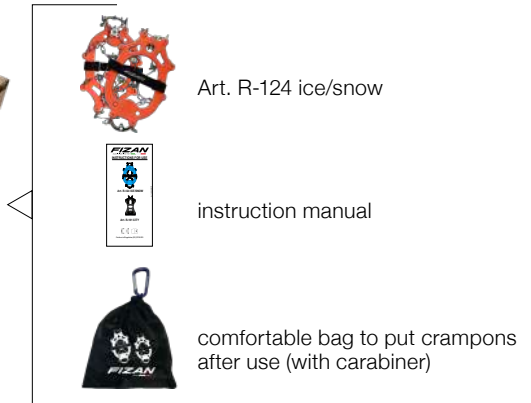

| SIZE | S (34-37) | M (38-41) | L (42-44) | XL (45-48) |
|-------------|------------|-----------|-----------|------------|
| PAIR WEIGHT | 345 gr | 355 gr | 365 gr | 375 gr |
| COLOR | light blue | orange | black | green |
| | | | | |

SNOW GAITERS Art. G-101

CHARACTERISTICS:
One size
reflective logo
polyester fabric,
waterproof 3000 W/R
zip and velcro strap
for front closure with
clips
lower leather band (under
shoe) for greater wear
resistance
easy to adjust thanks to
string in upper part



ACCESSORIES



TREK POLES BAG
Art. 202 TREK
size: 65 x 8 cm
(1 pair telescopic poles)



NW POLES BAG
Art. 202 NW
size: 140 x 8 cm
(1 pair nw poles)



GREY CAP
Art. 100.092
grey cap with black logo new
technical polyester fabric



POLES BAG ADJUSTABLE
Art. 218
size: 100-140 x 22 cm
(15 pair of poles)



GLOVES
Art. GL
size S or size M-L or XL
100% polyester stretch
gloves finger touch screen



PLEXY DISPLAY
Art. PLEXY
Size: 48 x 13cm
Plexy display for 6 poles



COMPACT DISPLAY
Art. 254
compact 4 display
Art. 253
compact 3 display



FIZAN FLAG
Art. FLAG2
Aluminium frame
40 x 200 cm



BLACK CANOPY
Art. CANOPY
with Fizan logo
Size: 300 x 300 cm

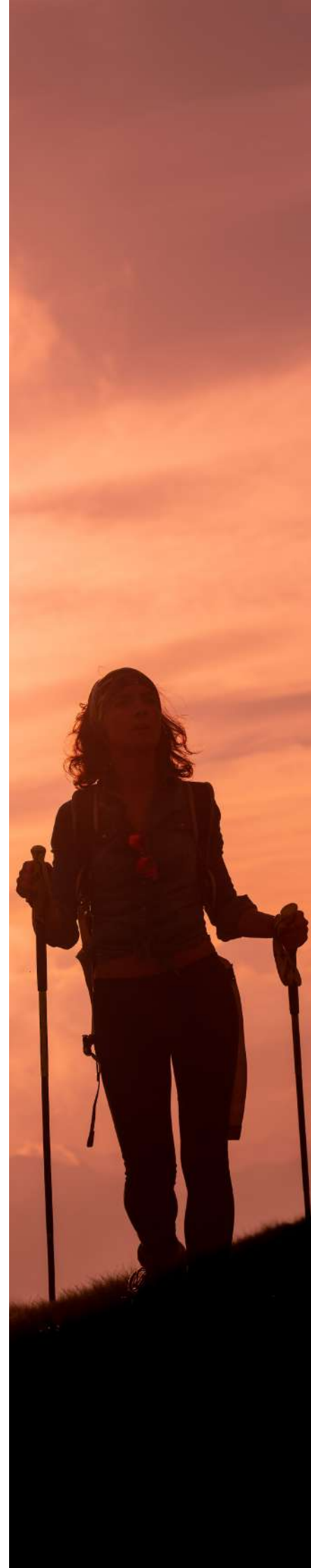

SPARE PARTS



Art. B-35
trekking basket 35mm



Art. B-50
trekking basket 50mm



Art. B-95
alpine basket 95mm



Art. B-120
powder pro basket 120mm



Art. B-55
alpine basket 55mm



Art. TS
e-basket steel tip



Art. TS MW
e-basket carbide tip



Art. TS LW
e-basket "L" carbide tip



Art. N35WB
nw basket 35mm
carbide tip



Art. N35WY
nw basket 35mm
carbide tip



Art. FR TREK
trekking strap
with FR system



Art. FR3-AIR
NW FR3 AIR strap
system size S / M / L



Art. TAR
race rubber
Art. TARR
race rubber w/ring



Art. TT
rubber tip
Art. TTR
rubber tip w/ring



Art. TN
nordic rubber tip
Art. TNR
nordic rubber tip w/ring



Art. LV
single lever in
black aluminium



Art. LB
block system
with lever in aluminium
size Ø18 mm / Ø16 mm



Art. 114AL +115AL
flexy expanders for 7001
3 section poles



Art. 114AL+116AL
flexy expanders for
7075 alu poles



Art. 112AL+114AL+115AL
flexy expanders for
7001-4 section alu poles



Art. 115AL
flexy expanders 15
(compact)



Art. 116AL
flexy expanders 16



Art. 114AL
flexy expanders 14



Confezionamento singolo per accessori con maniglia in cartone e sacchetto trasparente.

Single packaging for accessories with cardboard handle and transparent bag.



SUMMARY

| | CODE | NAME | PICTURE |
|----------------|---------|--------------------------|---------|
| TREKKING | 100.001 | COMPACT 1947 Desert | |
| | 100.002 | COMPACT PRO Grey | |
| | 100.011 | COMPACT 4 Water green | |
| | 100.012 | COMPACT 4 Grey | |
| | 100.005 | COMPACT Green | |
| | 100.006 | COMPACT Red | |
| | 100.007 | COMPACT Black | |
| | 100.008 | COMPACT Pink | |
| | 100.009 | COMPACT Ocean Blue | |
| | 100.010 | COMPACT Beige | |
| | 100.003 | COMPACT MS Black | |
| | 100.004 | COMPACT MS Magenta | |
| | 100.013 | ADVENTURE Desert | |
| | 100.014 | PRESTIGE AS Red | |
| | 100.015 | PRESTIGE Sugar paper | |
| | 100.016 | VOYAGER Petrol | |
| | 100.017 | TREK Grey | |
| | 100.018 | TREK Pink | |
| | 100.019 | TREK Light blue | |
| | 100.020 | TIERRA Beige/Water green | |
| | 100.021 | TIERRA Grey/Coral | |
| | 100.022 | EXPLORER Beige/Blu | |
| | 100.023 | EXPLORER Lime/Grey | |
| WALKING | 100.024 | PROMENADE Grey | |
| | 100.025 | CLASSIC MICRO Grey | |
| | 100.026 | CLASSIC MICRO Magenta | |
| SKI TOURING | 100.027 | ARIA Beige | |
| | 100.028 | ELBRUS Orange | |
| | 100.029 | LHOTSE Light blue | |
| FOLDING FFP | 100.030 | RFP TOURING Black | |

SUMMARY

| | CODE | NAME | PICTURE | |
|-----------------------|--|--|----------------------------|--|
| FOLDING FFP | 100.031 | RFP TRAIL Black | | |
| | size 107-120 100.032 size 117-130 100.033 | IMPULSE CARBON PRO Red | | |
| | size 107-120 100.034 size 117-130 100.035 | IMPULSE TEKNO RACE Grey | | |
| | size 105 100.051 size 110 100.052 size 115 100.053 size 120 100.054 size 125 100.055 size 130 100.056 size 135 100.057 | CARBON RACE Yellow | | |
| | 100.036 | CARBON PRO Yellow | | |
| | 100.037 | TEKNO RACE Yellow | | |
| | size 105 100.058 size 110 100.059 size 115 100.060 size 120 100.061 size 125 100.062 size 130 100.063 size 135 100.064 | RUNNER Gold | | |
| | size 105 100.065 size 110 100.066 size 115 100.067 size 120 100.068 size 125 100.069 size 130 100.070 size 135 100.071 | RUNNER Blue | | |
| | size 105 100.072 size 110 100.073 size 115 100.074 size 120 100.075 size 125 100.076 size 130 100.077 size 135 100.078 | RUNNER Pink | | |
| | NORDIC WALKING | 100.038 | R-EVOLUTION PRO Grey/Beige | |
| 100.039 | | R-EVOLUTION Yellow | | |
| 100.040 | | R-EVOLUTION Grey/Ocean | | |
| 100.041 | | SPEED RACE Grey | | |
| 100.042 | | SPEED Yellow | | |
| 100.043 | | SPEED Black | | |
| 100.044 | | SPEED Ocean | | |
| 100.045 | | SPEED Violet | | |
| 100.046 | | SPEED Pink | | |
| 100.047 | | SPEED JUNIOR Rainbow | | |
| 100.048 | | LITE 4 Grey | | |
| 100.049 | | LITE Sugar paper | | |
| 100.050 | | LITE Coral | | |
| | | size 107-120 WLXPR1001 size 117-130 WLXPR1002 | WALX PRO Black | |
| | | WLXVL1001 | WALX VELOCITY Black | |
| | WLXXP1001 | WALX XPLOER Black | | |

MULTI SCARVES

Gli scaldacollo Fizan sono perfetti per qualsiasi utilizzo e possono essere indossati in diversi modi! Sono realizzati in tessuto tubolare di microfibra di alta qualità senza cuciture, elastico e morbido al tatto. Il particolare sistema Microfresh favorisce la termoregolazione sia in estate che in inverno. Il tessuto in poliestere e gli inchiostri utilizzati, sono forniti solo da partner certificati. Garantiscono una protezione UPF 50+. Lavare a mano o in lavatrice in acqua tiepida con sapone neutro. Fizan riduce l'impatto ambientale con imballaggi 100% riciclabili, e composti da materiale proveniente da foreste gestite in maniera responsabile e sostenibile. Ogni singolo articolo prodotto è facilmente smaltibile per essere riciclato.

Fizan neck warmers are perfect for any use and can be worn in different ways! They are made of high quality seamless microfibre tubular fabric, elastic and soft to the touch. The particular Microfresh system promotes thermoregulation both in summer and in winter. The polyester fabric and the inks used are supplied only by certified partners. Fizan multiscarfs provide UPF 50+ protection. Hand wash or machine wash in warm water using mild soap. Fizan reduces the environmental impact with 100% recyclable packaging, and composed of material from forests managed in a responsible and sustainable way. Every single item produced is easily disposable for recycling.



WWW.FIZAN.IT FOR COMPLETE COLLECTION!



- Realizzato in Italia 100%**
Made in Italy 100%
- Moschettone Fizan incluso**
Carabiner Fizan included
- Confezione ecologica**
Eco friendly packaging
- Facilmente riciclabile**
Easily recyclable

Art. HEADBAND DISPLAY
Multi scarf transparent plexy display contains 12 blister. 24 x 49 x 21 cm





 SCAN ME



-  www.fizan.it
-  info@fizan.it
-  Fizan poles
-  [fizan_official_page](#)